



1FT LINEAR FIXTURE

INSTALLATION INSTRUCTION AC 1FT LINEAR LIGHT LLG0212180F

SAFETY INSTRUCTION

IMPORTANT: NEVER attempt any work without turning off the electricity.

- Please read all instructions before installation.
- Intended for installation by a qualified electrician in accordance with the National Electrical Code and local regulations.
- Go to the main electrical panel. Place the main power switch in the "OFF" position switch "OFF" the circuit breaker switch(es) that control the power to the fixture or room that you are working on.
- Place the wall switch in the "OFF" position.

Figure 1

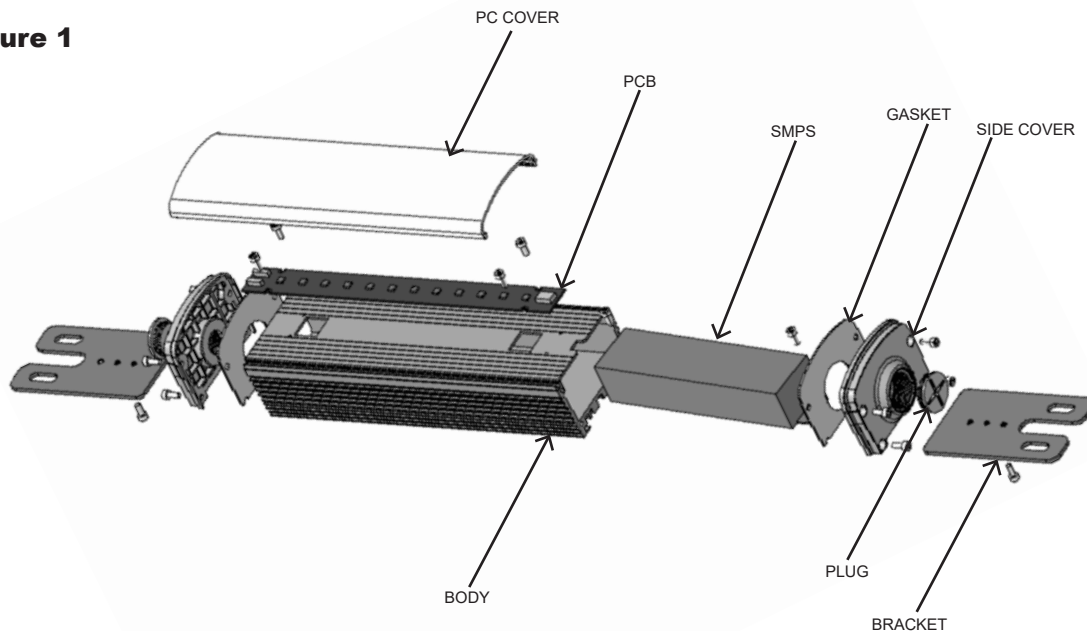

WIRING AND INSTALLATION

1. Remove side cover screws. (see Figure 1).
2. Separate the side cover from side of housing, unplugging side cover connector.
3. Using the 2 mounting brackets supplied, mount linear light in desired location in facility.
4. Remove desired $\frac{3}{4}$ " hole and insert desired wire and gland.
5. Connect ACL, ACN and Earth Ground using provided connectors.
6. Replace side cover.
7. Replace side cover screws.

* Suitable for continuous row mounting - 33 units maximum.